

INSTALLATION GUIDE



www.TheInteriorGallery.com

Tel: 214.614.8176

Model No.:TIG-619072

Cabinet Size:72"W x 22"D x34"H

Notes:

- Please turn off water-lines and drain before installation of vanity
- Drain, pipe and trap are not included
- Loosen the knobs inside drawers then install them correctly in the front

Packing list

- Main cabinet
- Countertop and backsplash
- Sink
- Instruction manual

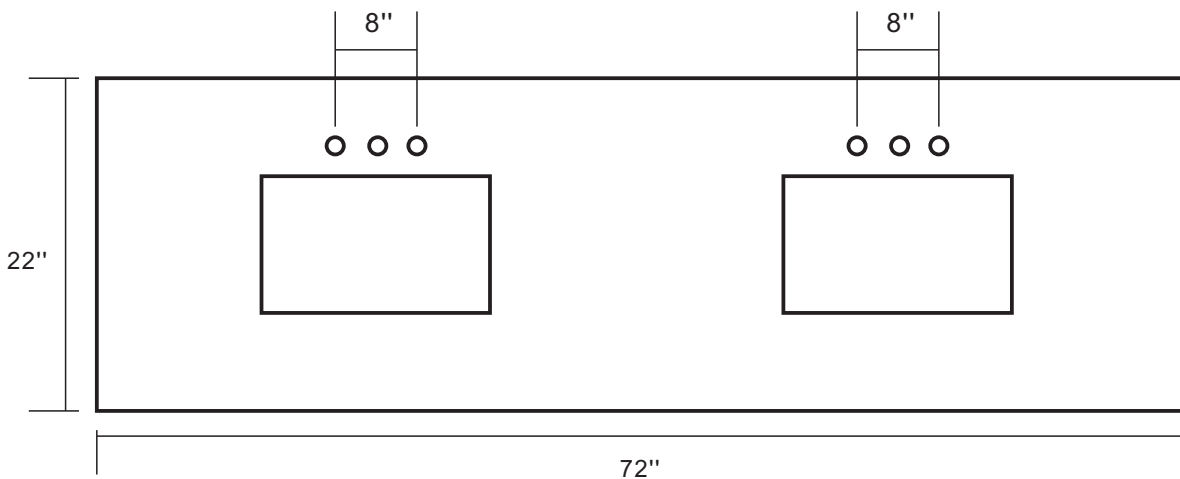

Top vertical view

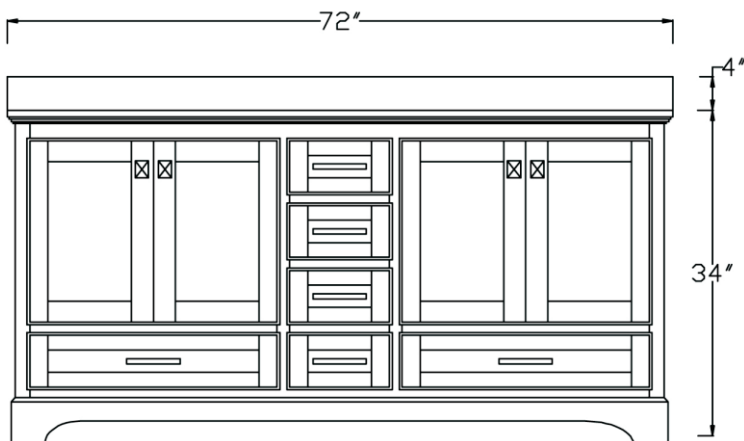

Front View

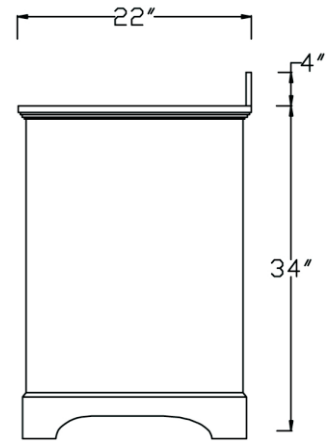

Side View

INSTALLATION GUIDE

- Stick the backsplash on the countertop using a transparent silicone and let dry

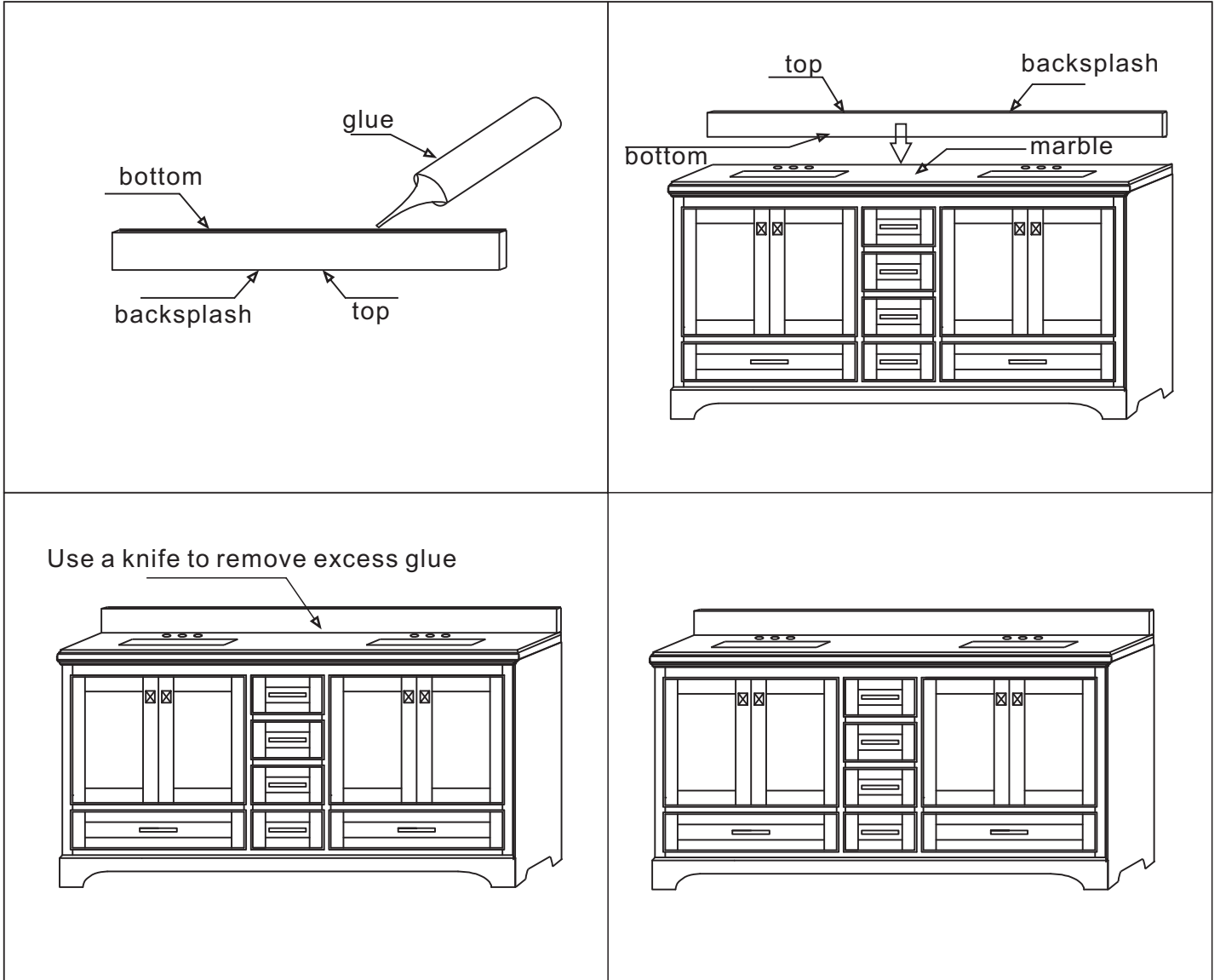

Installing the drain

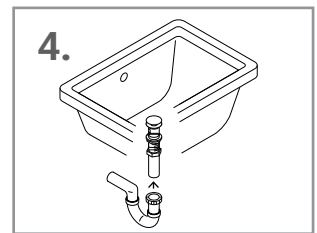
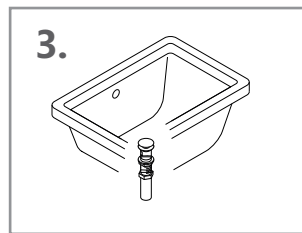
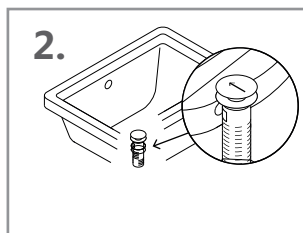
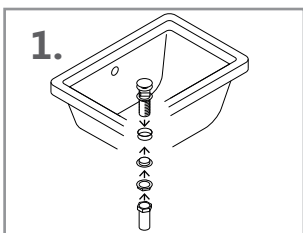

INSTALLATION GUIDE

- After installing the backsplash on the cabinet, put the drain assembly inside the hole in the sink and fix it firmly.
- Tie up the mounting rubbers and metal rings from the bottom of the drain.
- Connect the trap onto the drain bottom.

Hanging Mirror On The Wall

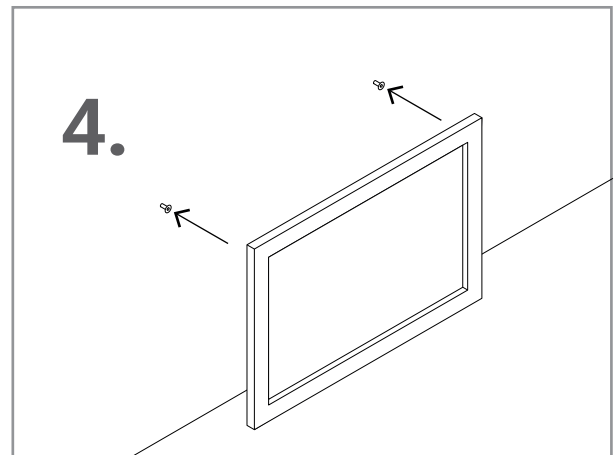
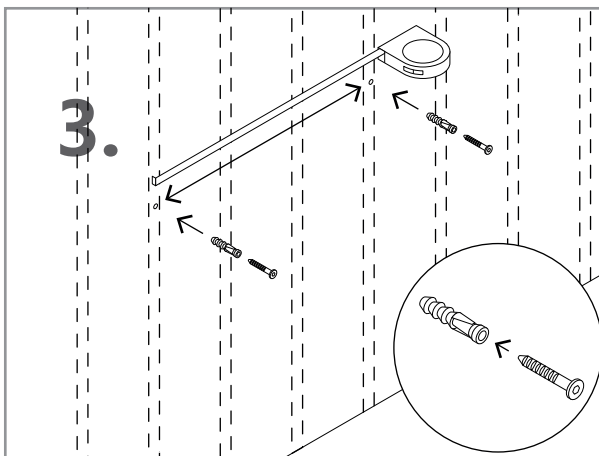
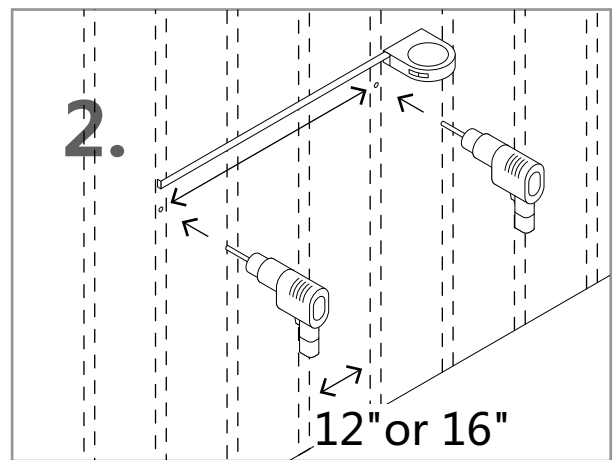
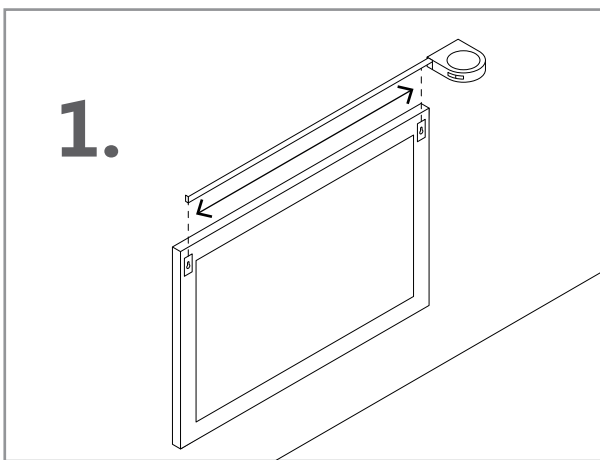

- Measure the distance between the screw holes from the back of the mirror.
- Locate the studs on the wall. They are normally placed 12" to 16" apart from each other. Drill two holes on the studs as per your previous measurement.
- Insert the plastic plugs into the drilled holes and then insert screws into the plastic plugs. Tie up the screws till they remain at least 0.5" – 0.75" outside the wall.
- Hang the mirror on to the wall